

# Energy limiter for radio controlled models

## TSS Limiter

### Quick start guide

---

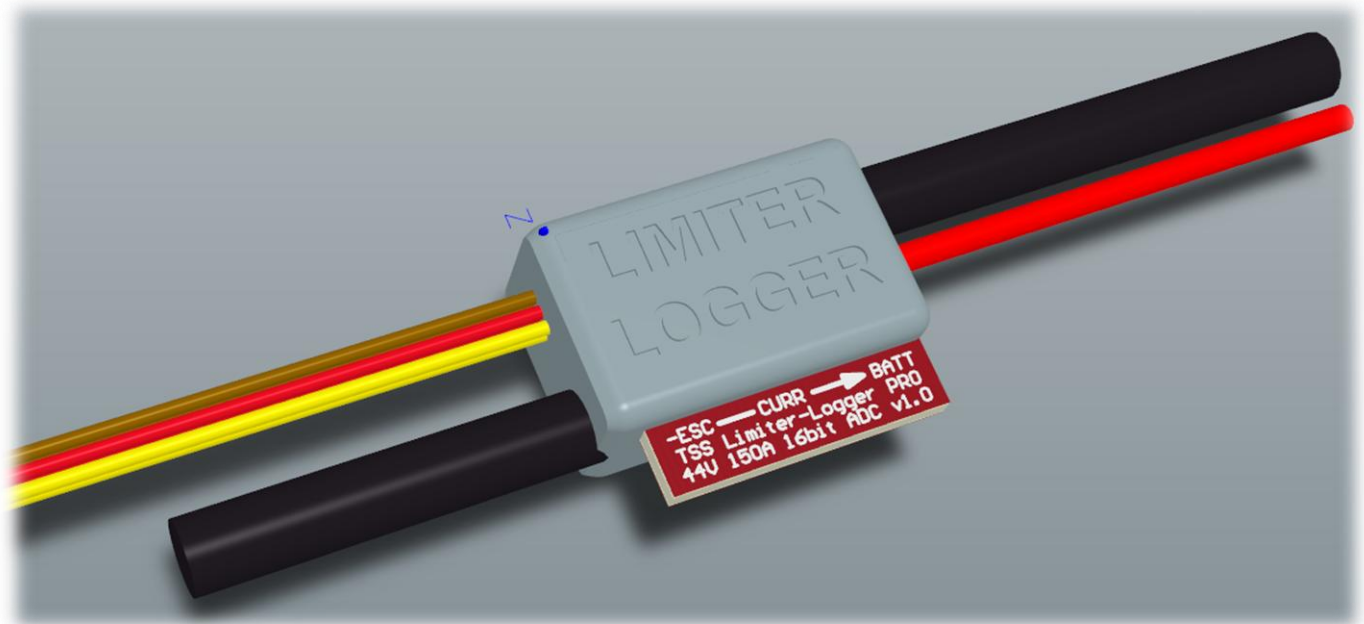





## Short description

For more detailed acquaintance with all modes of device operation (including the logger, realtime view, firmware upgrade), please refer to the User Manual, this document describes the most basic information only.

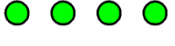

The device meets the requirements of NAVIGA for energy limiters, has **five sets of preset and non-variable settings, approved by NAVIGA**, in addition, there are custom sets of settings, which are described in the main Manual.

Current set of settings is displayed by LED indicator in the device body immediately after the power is switched on. The LED produces short (0.25s) and long (0.75s) flashes. LED flashes repeat every 5 seconds. Long flashes (if any) go before short flashes.

Short flashes correspond to the selected set of settings:

- If no short flashes - it is **training mode** (energy is not limited);
-  1 short flash - **21Wh** (Mini Eco, Mono, Hydro);
-  2 short flashes - **60Wh** (Eco Expert, Mono I, Hydro I);
-  3 short flashes - **120Wh** (Mono II, Hydro II);
-  4 short flashes - **180Wh** (FSR-E);
-  5 short flashes - **2Wh** (test mode).

Long flashes indicate the current mode of operation:

- No long flashes - the limiter is in standby mode;
-  1 long flash - limiter is in the energy counting mode (in the race mode);
-  2 long flashes - energy is over and limiter is in the energy limiting mode.

**Example:**

You have chosen the second settings set. When you turn on the limiter, LED will make two short flashes (corresponding to the 60Wh mode), every 5 seconds. When current exceeds 3A\*, limiter switches to energy counting mode, and led will change as follows: to two short flashes a long one is added. The flashing frequency of this triple series is long-short-short: every 8 seconds.

Switching between sets of settings is carried out using the button (optional) or using a mobile phone with the Android or iOS operating system. Connect the button to the signal connector from the receiver, press the button, sets of settings will be switched in a circle, the procedure is described in more detail in the main Manual. Setup by phone is described in detail in the main user Manual.

For all presets, the following additional settings are set up:

Setting	Value	Note
Start current	3A	
Throttle limitation (% from full)	0%	That is a complete shutdown
Time of rampdown	5s	
Time of throttle limitation	60s	Before restarting the limiter

**The current mode of energy counting (race) is reset automatically after you fully disconnect limiter from battery (including red voltage sensor wire). Disabling the main supply (emergency loop) of the limiter power does not reset the energy count.**

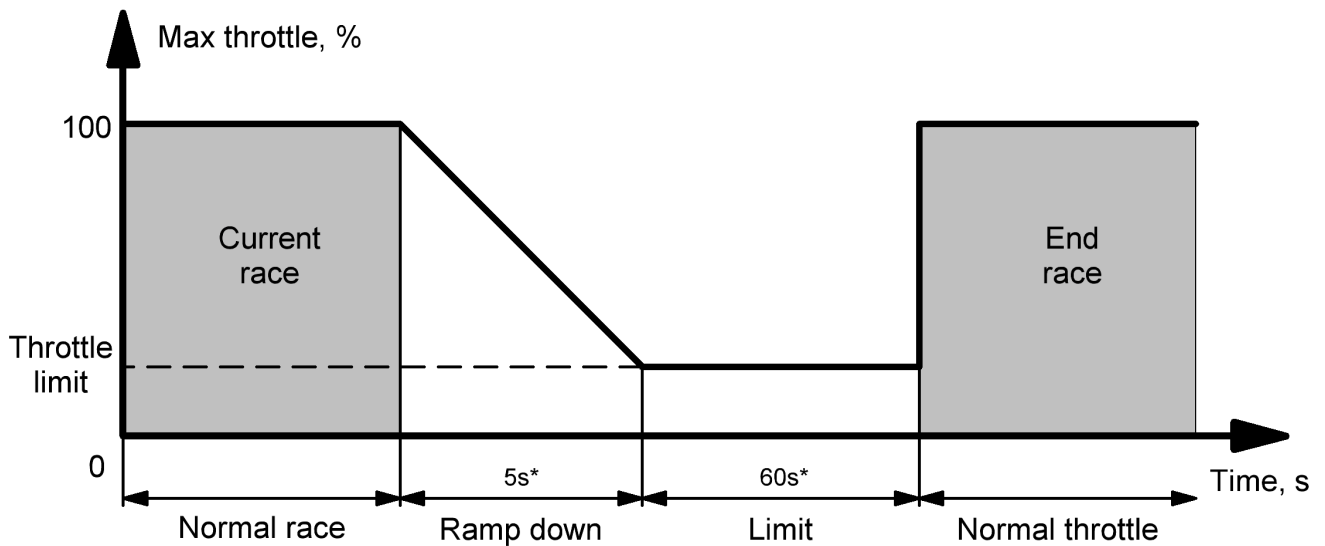

During the race, there is no need to reset the energy count, however you can connect the configuration button and hold it down for 10 seconds, this will reset the current energy counting mode and device will be ready for the next race.

### Device connection

Connect the device according to the scheme below:

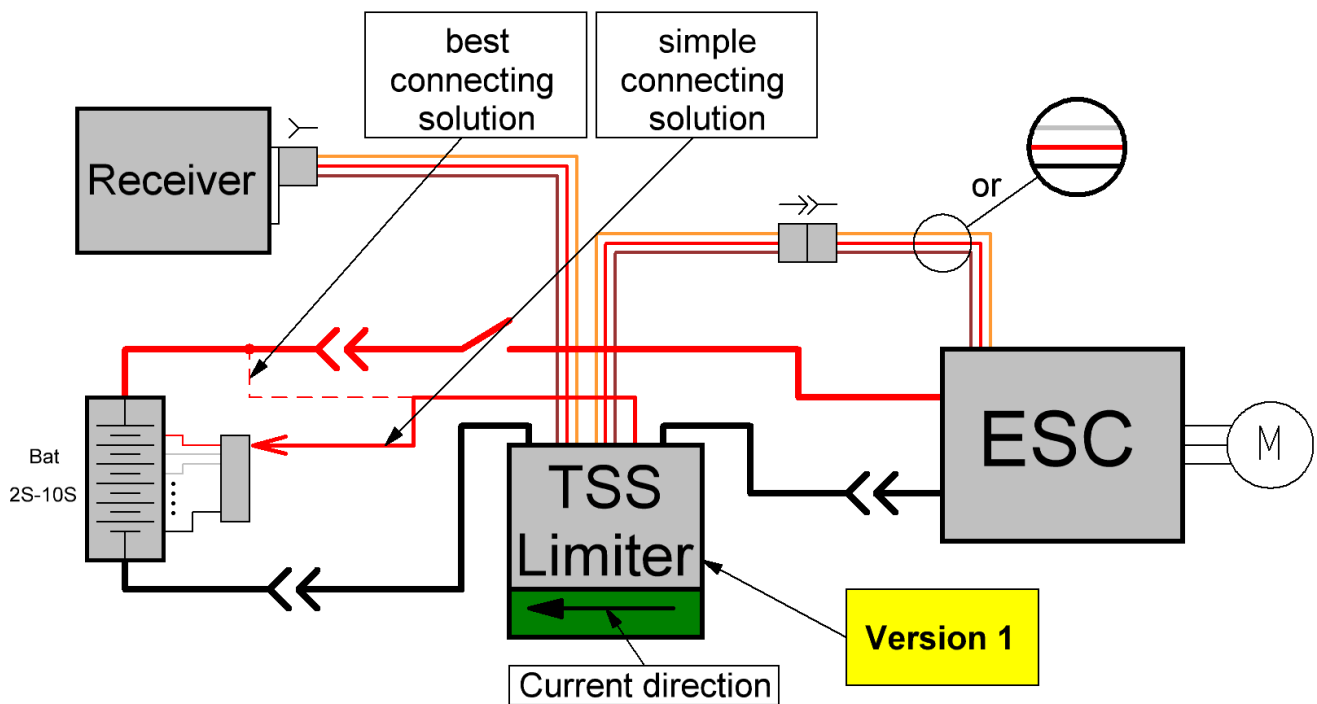

## Indication

Indication is carried out periodically according to the following algorithm:

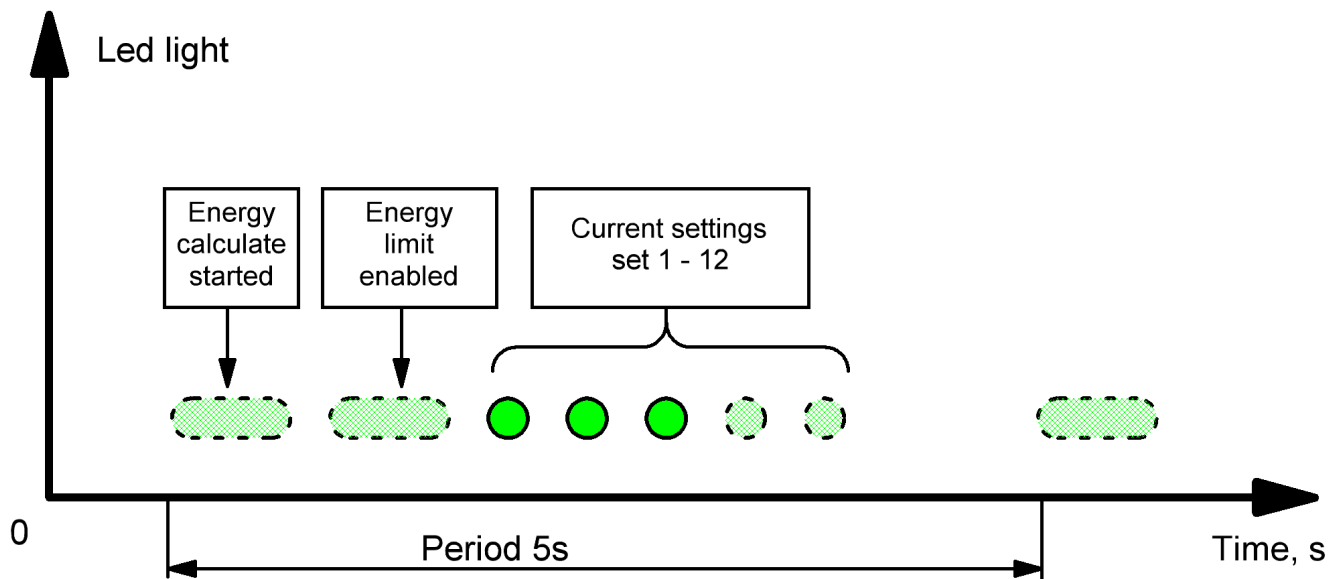

## Setting of throttle grip

Using a limiter, pay special attention to the correspondence of the throttle grip position on the transmitter with positions of zero and full throttle in the ESC. The limiter counts the limit (0% by default) from the zero position of the throttle grip on transmitter, therefore, if the controller uses a narrower operating range, this will lead to a complete stop instead of the limiting!

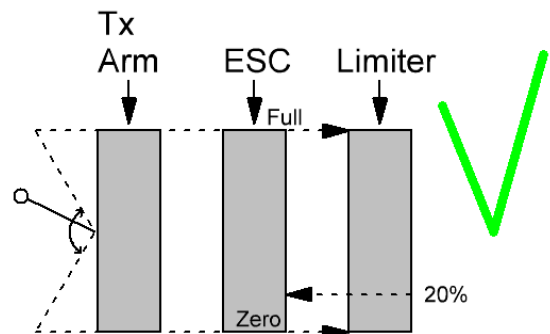
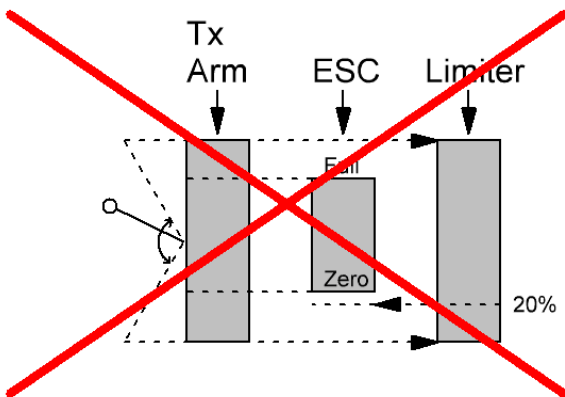

## Technical specification

Parameter	Value	Note
Measured voltage	0 – 44V	DC
Measured current (up to 20 sec)	1 – 150A	
Measured current (continuously)	1 – 100A	
Energy measurement accuracy	±1.0%	
BEC voltage	4 – 13V	
Type of communication interface	BLE	Bluetooth Low Energy 5.0
Communication Interface range	100m	In direct visibility
Receiver signal	0.7 – 2.3ms	Standard PPM 3.3-10V
Working temperature range	0 – 50°C	
IP rating	IP67	
Dimensions of the device	22.5 x 19.5 x 10.5mm	No wires included
Weight	18g	Including all wires and connectors
Length of the power wire	100mm	
Type of the power wire	AWG10	

**The device has a mechanism for updating the firmware by a mobile phone, so when new requirements for NAVIGA appear, they will be available in the new firmware, which you can upgrade yourself. There is no need to send a limiter anywhere.**

For more detailed acquaintance with all modes of device operation (including the logger, live view, firmware upgrade), please refer to the User Manual for this document describes the most basic information only.

## **Warranty and servicing**

Manufacturer guarantees that the device has been tested at production site, calibrated and is fully operational. In case of a factory defect detection, the device can be made warranty repair within 12 months from the date of sale, this period as agreed may be extended to the time of delivery by mail.

The warranty does not cover damage of the device caused by connection errors, exceeding the maximum permissible values of currents and voltages, and the associated overheating.

For warranty service please contact us by e-mail.

## **Manufacturer**

Turnaev Sergey

Moscow, Zelenograd

124489, building 605, office 13.

E-mail: [tsslimiter@gmail.com](mailto:tsslimiter@gmail.com)

Web Site: <http://tsslimiter.com>